



READ THESE DIRECTIONS CAREFULLY before unpacking your Garden Tower!

*WARNING: CHILD CHOKING HAZARD - Product contains marble-like bearings or small balls

UNBOXING (VERY IMPORTANT) Open top of box, remove all loose parts: five (5) loose rings, six (6) compost tube sections, one (1) screen. Next, use the exposed center opening below the parts to reach into and lift out the base and attached base ring from the box while being careful to keep the drawer from sliding out of the base. Finally, verify that all additional parts are present (refer to graphic "1").

THESE RECOMMENDATIONS AND ASSEMBLY INSTRUCTIONS CAN BE VIEWED IN VIDEO FORMAT (coming soon) AT: www.GardenTowerProject.com. New video tutorials will also be available in a few weeks.

Congratulations on your purchase of the 100% American-made Garden Tower. In most regions the tower can be planted in the spring with vegetables, flowers, and herbs, and again in late summer for the fall season. Temperate climates allow for three or even four complete crop cycles per year with advanced planning.

LOCATION: Choose a place that provides the most sun possible throughout the day, easy accessibility, and stability. It's best to place your Garden Tower on a hard surface; if that's not possible, place under each foot, a brick or some other hard flat object that is at least slightly wider and or longer than the provided feet. Taking these steps is imperative if you place your Garden Tower on a lawn to keep it from sinking into the ground.

SOIL: Using "potting soil" is essential. A quality commercial potting soil (or "grower's mix") will optimize drainage, water retention, and aeration for both plants and the compost. We recommend you ask your nursery for a lightweight or fluffy grower's mix or potting soil (organic is best but not required). Detailed suggestions are on our website resources page (www.gardentowerproject.com/resources). Many "grower's mixes" are completely free of fertilizers. If purchasing a plant food to fortify your soil mix, make sure to purchase a naturally-derived plant food (we recommend staying away from animal manure products as they have an overabundance of salts) to mix with your soil to kick-start the movement of nutrients through the tower (the application rate for a general purpose organic 4-4-4 is up to 1 cup / cu ft. soil).

PLANTING: A great variety of vegetables, herbs and flowers will flourish in your Tower. A partial list is available at our website at (www.gardentowerproject.com/faqs). Seasonality, size, and personal preference will help determine your choices. Some basic rules of (green) thumb: 1) Large plants such as tomato and pepper do best on top, 2) trailing vines such as squash or cucumber do best on the bottom row, 3) try to choose plants with similar mature size for the side pockets so the plants don't shade each other out, 4) you can begin with seed or small starts (available online, at garden centers, and farmer's markets). Garden Tower Project supports and recommends the use of Non-GMO plants.

WORMS: The central vermacomposting tube is a key feature of your Tower. Red wiggler worms and nightcrawlers, available online (**save 15% with coupon "GTPFamily" at www.unclejimswormfarm.com**) and at bait shops, will quickly break down your kitchen scraps as you place them in the central tube and will distribute their castings throughout your tower to nourish your plants. Vegetable and fruit scraps (avoid citrus), leaves, shredded paper and cardboard, old wood chips, grass clippings are all great fodder for the worms. Avoid grease and all animal products except eggshells. With the central compost tube filled with at least 6-8 inches of scraps, place a half to one cup of red wigglers in the tube, replace the cap and let the worms do their work. **Do not order your worms until your tower is in use and daytime temperatures are generally over 50 degrees!**

COMPOST TEA: As the worms pass throughout the system, they will leave manure behind in the soil and compost. When watering the tower, the water collects many of the nutrients provided by the worm manure. Any water not immediately absorbed by the soil will drain into the drawer at the bottom of the tower. Re-apply this water quickly.

COMPOST: Your Garden Tower will produce rich, black vermacompost (organic fertilizer) for you to use. After two or three months of adding scraps to the central composting tube, it will be ready to harvest. To remove and use this vermacompost, follow the steps outlined in the instructions portion of this manual. If you choose not to use the central tube for composting, you can simply fill it with potting soil as you fill the rest of the tower; just be sure to maintain a regular feeding schedule for your plants using a high quality organic plant food.

WATERING & ONGOING CARE FOR YOUR GARDEN TOWER: As a self-contained, self-fertilizing system, the Tower requires limited care. A general watering schedule during the active growing seasons is 4-6 gallons of water every 2-3 days. We recommend strongly against watering with a hose because it is very difficult to learn how much water your tower is truly requiring. By watering with a container you will learn quickly how much water is ideal. Test the soil for dryness by placing a finger in a pocket in the lowest row. If the soil feels dry, a heavier watering is required (5-7 gallons), if the soil feels slightly moist, maintenance watering is all that is required (2-4) gallons. If water is draining into the drawer more often than twice per week, you're watering too frequently. A layer of mulch on the top surface of the tower will help maintain constant moisture. Tend to your garden as you would with a regular garden, remove dead or damaged leaves, cutting back unruly growth, replacing harvested plants. When winter arrives, you can move your tower to a heated location, or just leave it outdoors and replant in the spring. Flip the drawer over to prevent ice buildup. Read about wintering-over redworms under our website resources tab.

ASSEMBLY INSTRUCTIONS:

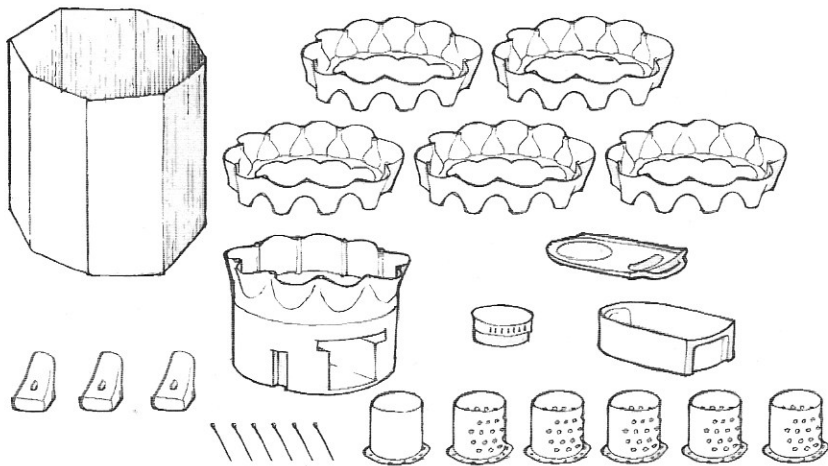

1: Parts List • (5) Removable planting rings • (1) Base with rotatable lower planting ring • (5) Compost tube sections with holes • (1) Upper compost tube section without holes • (1) Compost tube cap • (1) Sliding compost screen • (1) Drawer • (3) Feet • (6+) Zip ties • (1) Compostable carton

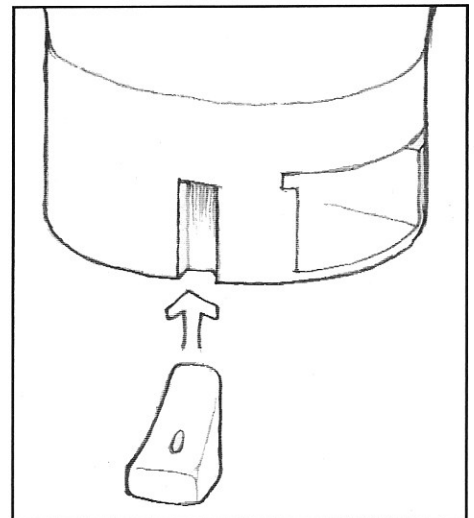

2: Slide each foot into the channels in the base being careful to keep fingers clear of the channel. Do not test-fit the feet, they are designed to stay securely installed.

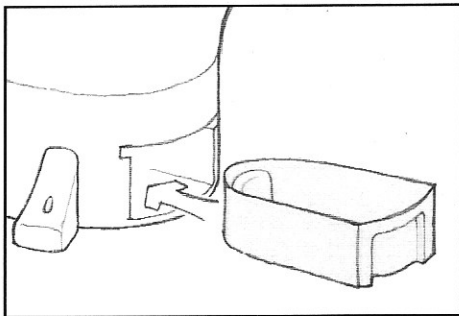

3: Slide the drawer into the base. When transporting the base please remove the unsecured drawer.

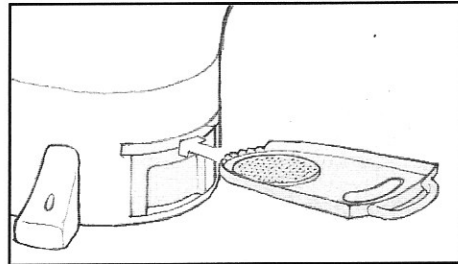

4: Slide the screen into the screen cavity above the drawer, as shown in drawing. Make sure the curved teeth in the front edge of the screen are facing upwards. It is normal for the screen to fit tightly into the track in the base.

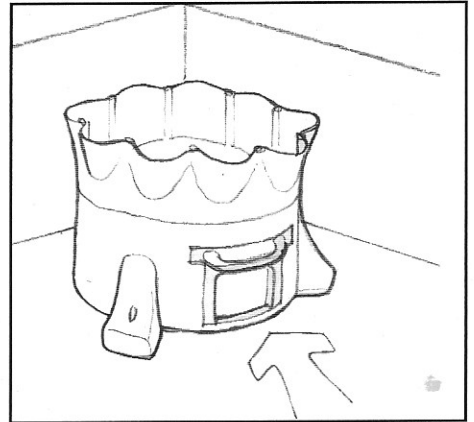

5: Place the Garden Tower in the exact location that you intend to use it (it will be difficult to move once heavily loaded and watered). Orient your tower so the drawer is pointed toward an open accessible area. If you intend to grow trailing vines like squash or melons make sure there is enough room around the tower for plants as well as these types of plants will interfere with the Garden Tower 2's rotation feature. For all other types of plants we suggest placing your tower at least two feet away from any wall or railing where possible. Trellising vining plants (beans, tomatoes, bush squash, etc.) can be easily accomplished with 18-36" stakes inserted in the planting rings.

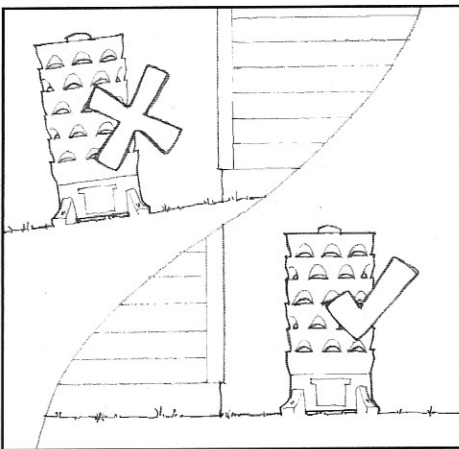

6: Choose a level location for your tower. If none exists, level your tower with solid objects. See next diagram.

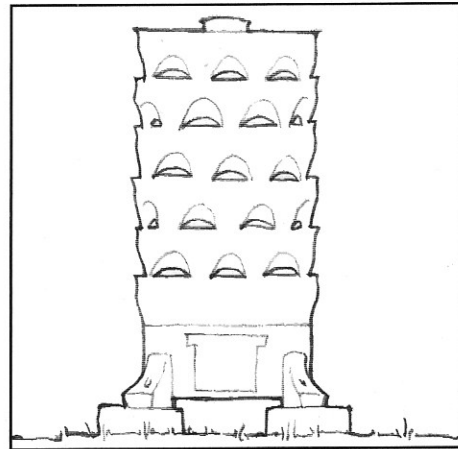

7: If locating the tower on lawn or soil surface, you must place solid large objects (such as bricks, pavers, rocks) under each foot to prevent Garden Tower from sinking.

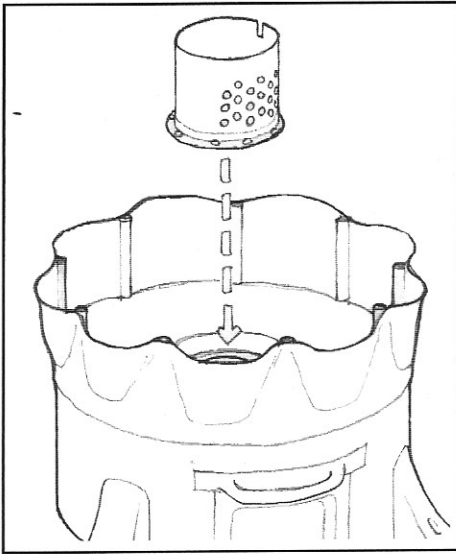

8: Place a perforated compost tube section onto the center top of the base ring (attached to the base) in the exact center. Align the compost tube with the drain holes in the base ring using the vertical tab running down the inside wall of the tube (the tab slides into the open slit in the base ring).

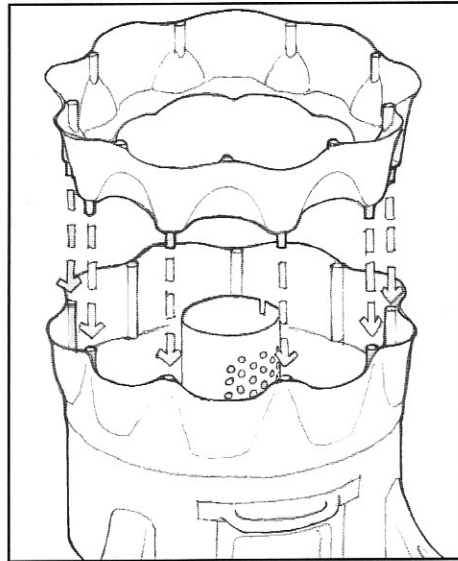

9: Place a loose planting ring (they are all identical) on top of the base ring (attached to base) making sure to align all posts at the bottom of the loose ring with their corresponding holes at top of the attached base ring. Press down firmly until fully seated (a rubber mallet or wooden block can be used to gently tap the rings together if necessary).

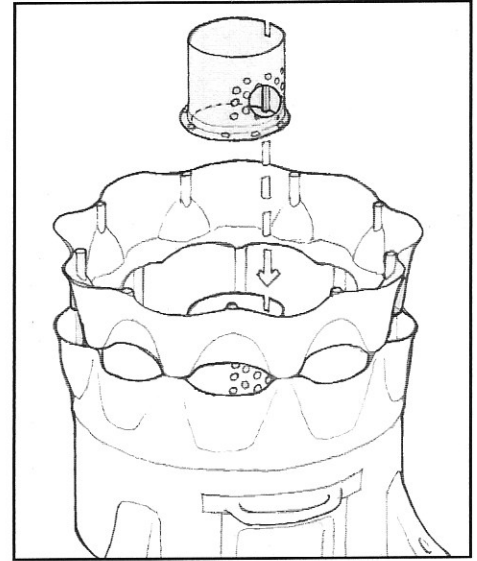

10: Place a perforated compost tube section onto the tube section previously mounted on the base ring making sure that the vertical tab on the inside of the compost tube is aligned with the corresponding slit on the top of the mounted tube.

STOP GO TO #13 (Page 6)
BEFORE LOADING SOIL:

Approximately 6 cubic feet of potting soil / grower's mix required.

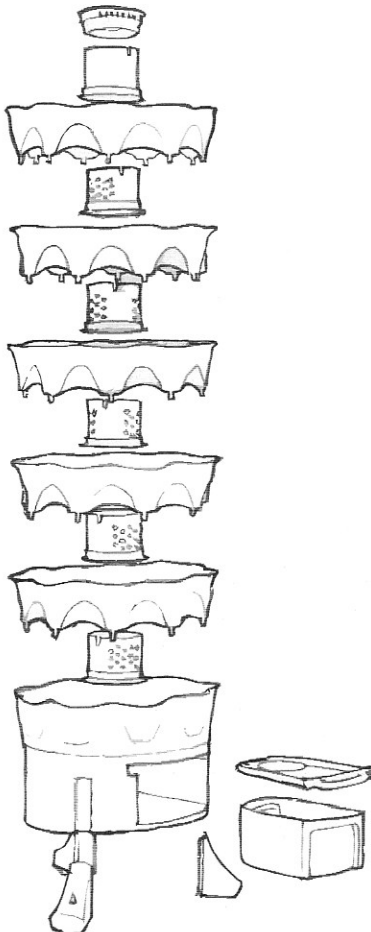

11.

11: Repeat step 9 placing any loose planting rings on top of previous ring, now repeat step 10 placing the perforated compost tube pieces on top of previous compost tube piece. Continue placing rings and compost tube pieces in alternating fashion until all pieces have been attached. The solid or blank compost tube section without holes should be placed in the top position of the column.

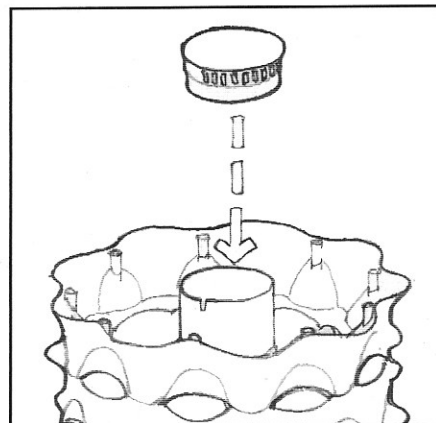

12: Place compost tube cap on top of completed compost tube.



14: Slowly pour soil from above into the body of the Garden Tower. Make sure to load all sides evenly. Fill approximately 1/3 of the way up.



15: Evenly pour 3 gallons of water, from the top, onto the soil that you just loaded. Repeat steps 14 and 15.

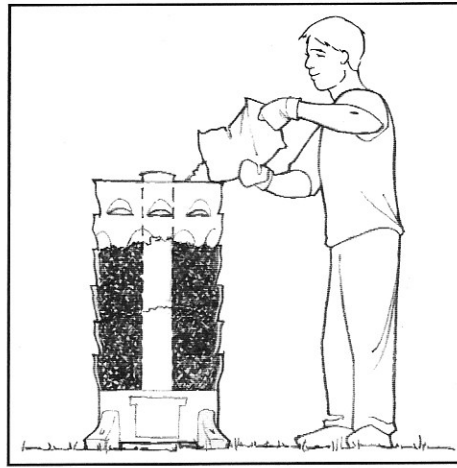

16: Finish pouring soil until it is approximately one inch from the top of the top ring. Reuse water & soil from drawer as necessary.

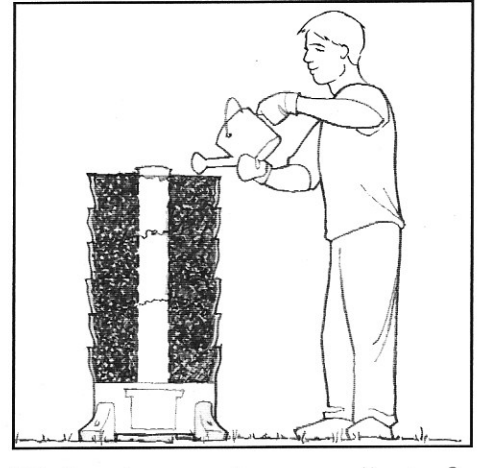

17: Evenly pour 4 more gallons of water, from the top, onto the soil. Perform step 22 and repeat as required.

PLANTING: Some basic rules of (green) thumb when planting your Tower.



18: A great variety of vegetables, herbs and flowers will flourish in your Tower. A partial list is available at our website at www.gardentowerproject.com/resources Seasonality, size, and personal preference will help determine your choices.

- Large plants such as tomatoes are a great choice for the top of the tower and can be trellised/ staked many feet in the air. (Tip: Plant tomatoes very deeply in the soil for steady access to water.)

- Trailing vines such as squash and zucchini do best on the bottom row, will require more floor space to accommodate their growth, and most importantly will make your tower very difficult to rotate. If you have limited space, or wish to have the option of being able to rotate your Tower, these type of plants may not be your best choice. (Tip: Look for "bush" varieties of these vining or trailing veggies as they are more collected and much easier to grow in small spaces.)

- Pay attention to the space requirements of the plants you're planning to grow and consider spacing plants that require less space between plants that require more space. Planting identical plants in diagonal columns or in small clusters of three to five generally performs well and looks beautiful.

- You can begin with seed or small starts, available at garden centers and farmers markets. (Tip: Start your seeds in soil in a compact flat or tray where they will grow into small starts for easy transplanting. Water your seeds with a misting sprayer.)
- When planting side pockets, start at the bottom row with your bushiest mature plants. Working up the rows, choose your next plants according to size (and other factors) as you plant; you are looking to choose plants of decreasing mature size as you plant from bottom to top. (Tip: Check out our "companion planting" resources for more information on what plants grow well together.)
- Adding an organic, non-manure-based plant food to the soil makes nutrients immediately available in the system. Liquid organic plant food mixtures will provide the most available nutrition for young plants. As the central compost tube begins to produce its own fertilizer, this will no longer be necessary.

WATERING SEEDS OR SEEDLINGS:

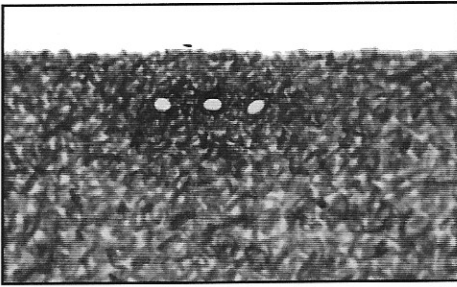

19: When planting with seeds, make sure to follow instructions on seed package as some seeds require different amounts per pot then others to ensure germination. Usually a seed will also require 1/8 to 1/2 inch soil to be place on top of seed to ensure that the seeds do not dry out.

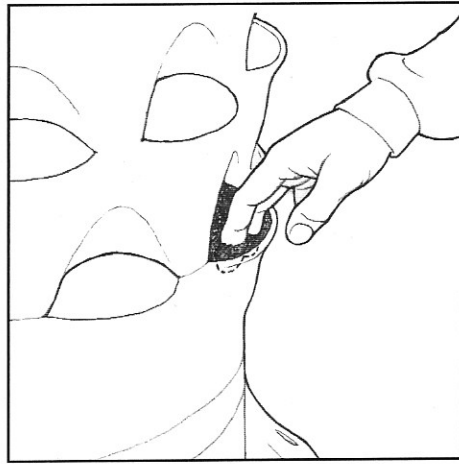

20: When starting with seedlings, (small starts or starter plants) clear a space in the soil of the side pocket equal to the size of the root ball, gently loosen the rootball with fingers and place the rootball in this open space and lightly press down around the base of the plant to ensure that the plant is secure.

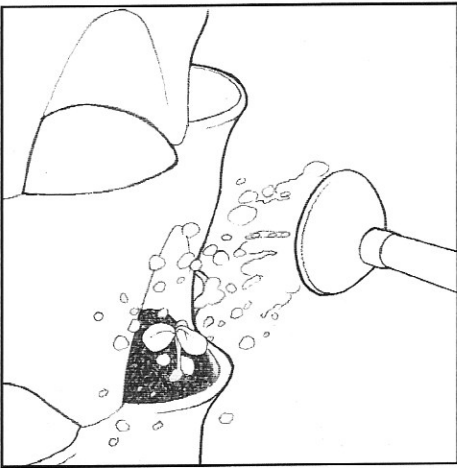
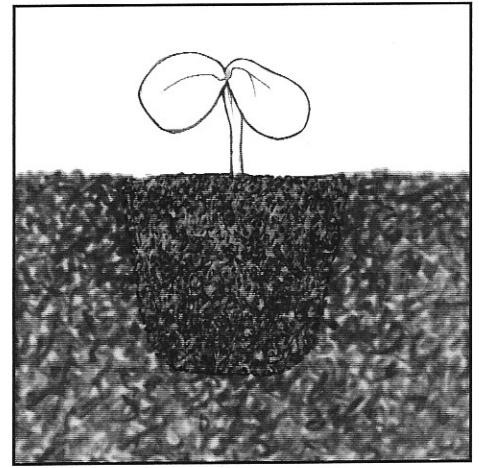

21: When watering seedlings, we recommend using a watering can with a water diffuser to ensure that you do not damage the plant. Keeping your seedlings moist for the first two weeks is important. Before and after work is recommended.

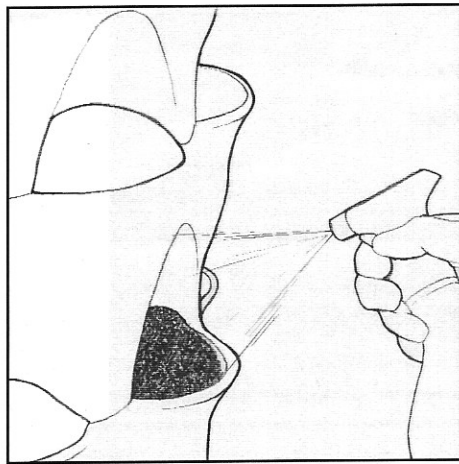

22: When starting with seeds it is recommended that you use a spray bottle to moisten the soil so that you don't upset the seeds. If using anything other than a spray bottle, take great care to disturb the soil as little as possible so that you don't upset the seeds.

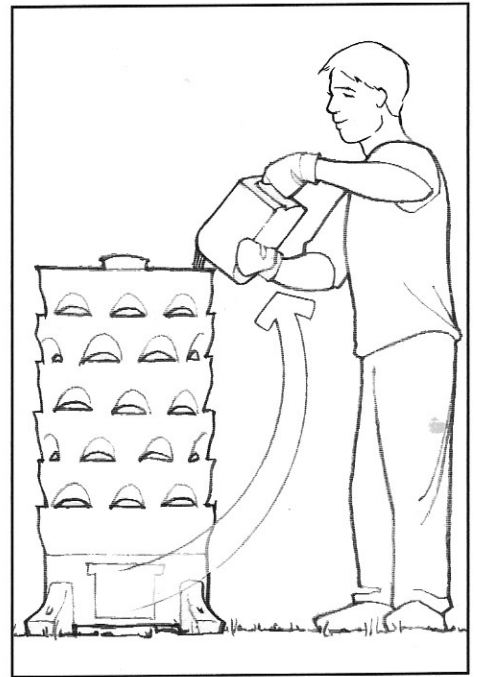

23: The drawer should be checked every day the system is watered. Any water sitting in the drawer should be poured back into the soil at the top of the tower within hours. This water contains many nutrients and minerals that are collected while passing through the soil, so recycling it back into the system is important. The longer the water or "leachate" sits in the drawer, the more oxygen is consumed and the less helpful it becomes.

Take photos of your tower at various growth stages for our monthly photo contest! Dogs, kids, yourself, butterflies, fresh harvests, compost, lady bugs, etc. all make for more interesting shots!

We're giving away a Garden Tower 2 to the winner every month! You can submit at www.facebook.com/gardentowerproject or www.gardentowerproject.com/testimonials/photo-contest

EMPTYING VERMACOMPOST TUBE:

Emptying a portion of the compost tube is recommended at the end of each growing season (or earlier depending on use and conditions). If you choose to not actively compost in your tower, make sure to follow a regular schedule of care with a quality natural plant food following the product use recommendations.

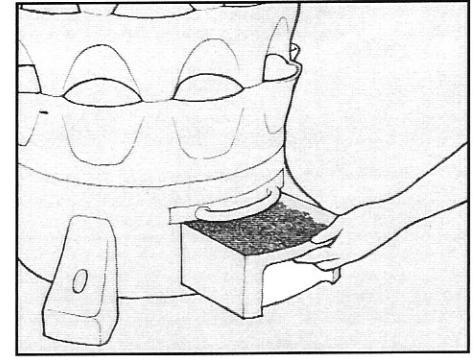
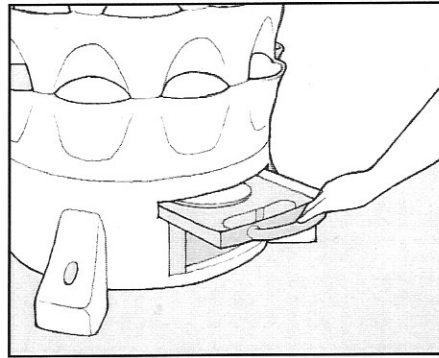

25: Remove the drawer and place vermacompost on top of the soil at the top of the tower. Your soil will have had time to settle a bit at this point, so it is recommended that you place a thin layer of vermacompost on top of the soil (1-3 inches or more if possible, being careful not to exceed height of top ring section). If appropriate, repeat the process again and continue emptying the compost tube until completely empty. Any excess vermacompost can be used on your house plant, garden flowers, gifted to a friend or saved to periodically help rejuvenate the soil in your Tower. We hope you fully enjoy your Garden Tower 2. Please visit our website often for lots of helpful hints, recommendations, tutorial videos, photo contests etc.

Look for our Garden Tower Green House coming out this fall!

GardenTowerProject.com

Illustrated by:
www.krystalriverdesign.com

24: It is recommended that you empty a portion of the compost tube when the tube is full of vermacompost. Make sure that the worms have fully worked through all of the kitchen scraps. To empty compost tube, make sure the drawer has no water in it, then pull the screen out half way to allow vermacompost to exit the bottom of the compost tube, and fall into the drawer. Now push the screen back in. Depending on the degree to which plants have rooted into the compost, it may be necessary to persuade the movement of the compost column with wooden handle.

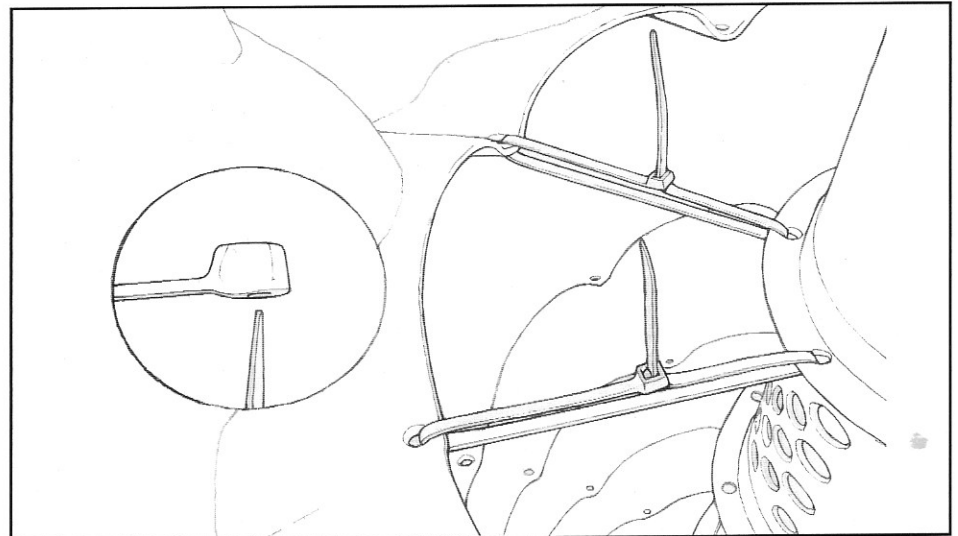

13: Optional: To stabilize compost column while adding soil, attach the zip ties as shown in illustrations: 1) Before attaching any zip ties, look at the drawings below to observe the placement and how each zip tie is oriented when attaching. 2) Notice the zip ties work in pairs with space between them. All zip ties secure the top ring to the top compost tube section. 3). Starting anywhere (any hole) on the top ring, thread your first zip tie through the ring hole and then through the compost tube hole exactly like shown in the drawings. Now thread the pointed end of the zip tie through the fat end of the zip tie (refer to drawing) and stop immediately when you first hear the clicking noise. The zip tie will be very loose, and that is okay! Repeat this process with the remaining zip ties in the exact arrangement you see in the drawings. 4) Slowly and evenly tighten all the zip ties maintaining the central alignment of the compost tube. Return to step 14 on page 3.

